

# New Version of Mevva Vacuum Arc Ion Source<sup>1</sup>

I.G. Brown\*, A.G. Nikolaev, R.A. MacGill\*, E.M. Oks, K.P. Savkin, and G.Yu. Yushkov

*Institute of High Current Electronics, Russian Academy of Sciences, 2/3 Akademicheskoy Ave., Tomsk, 634055, Russia, Phone: 8-(3822)-491776, Fax: 8-(3822)-492410, nik@opee.hcei.tsc.ru*

*\* Lawrence Berkeley National Laboratory, Berkeley, California 94720, USA*

**Abstract** – Vacuum arc ion sources have been designed and used by a large number of research groups around the world over the last twenty years. The first "generation" of vacuum arc ion sources named Mevva (Metal Vapor Vacuum Arc) ion sources was developed by Plasma Application Group, Lawrence Berkeley National Laboratory. This paper considers the design, parameters, and some applications of a new version of this source Mevva V.RU. The changes introduced in the source design consist in an improved ion-accelerating system, a hollow anode which is made dismountable for its easy cleaning from deposited material or macroparticles, and air cooling of the source. The source produces a broad beam of metal ions with a voltage of up to 50 kV and with an average ion current in mA range.

## 1. Introduction

Nowadays the use of high-current ion beams with energies ranging from several kiloelectronvolts to hundreds of kiloelectronvolts is one of the most promising trends in modern technologies of surface treatment and synthesis of new materials [1, 2]. The advances in this field and the expansion of the range of application of these technologies require the design of radically new ion sources as well as the improvement of currently available ones. In this connection, the progress of vacuum arc ion sources holds much promise, since this type of discharge is often the most feasible and, sometimes, the only way of producing the plasma of metals and other conductive solids. This paper considers the design, parameters, and some application of a new version of the Mevva-V ion source.

The studies aimed at optimizing the parameters of the initiating discharge and the longstanding experience of TITAN-type ion sources [3] have inspired the modification of the Mevva-V ion source designed in Lawrence Berkeley National Laboratory (USA). A detailed description of the Mevva-V ion source can be found in [4]. The new version of this source was given the name Mevva-V.RU and was patented in the Russian Federation [5]. The authors of this paper are the designers of this version and the patentee is the Institute of High Current Electronics, Siberian Branch of the Russian Academy of Sciences.

## 2. Design of the Mevva-V.RU ion source

The design of the Mevva-V.RU ion source is shown in Fig. 1 and photos of the source and its electrode system are shown in Figs. 2 and 3, respectively.

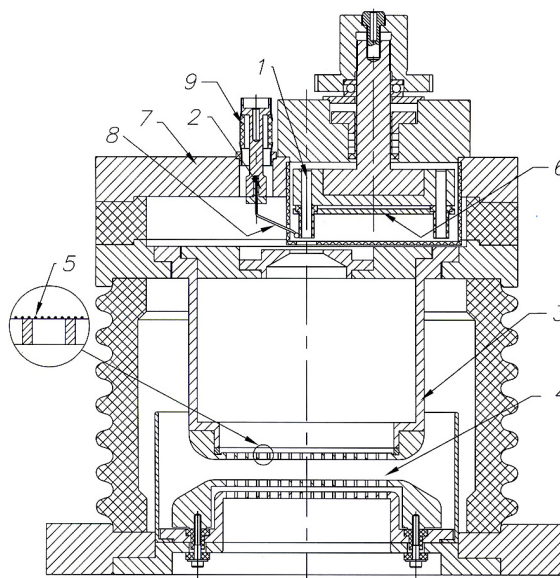

Fig. 1. Design of the Mevva-V.RU source of wide-aperture metal ion beams: 1 – cathode located on the carousel-type device, 2 – lead-in of the "trigger" discharge, 3 – hollow anode, 4 – ion-optic system, 5 – grid of the plasma electrode, 6 – tantalum shield of the cathode unit, 7 – cathode flange, 8 – spring electrode of the "trigger" discharge, 9 – ceramic bushing insulator of the source

The device incorporates a freely rotating carousel-type cathode consisting of 16 cathodes. This unit allows quick replacement of active cathode 1 without deterioration of the vacuum sealing of the ion source. Besides, the source comprises a discharge initiating system based on an auxiliary surface discharge 2, hollow anode 3, and multi-aperture three-electrode system of ion beam extraction 4. The cathode holder and the initiating system are located on cathode flange 7.

The ion source operates as follows. An initiating discharge voltage pulse with an amplitude of 2 kV is

<sup>1</sup> The work was supported by project RFBR # 05-02-16256a.

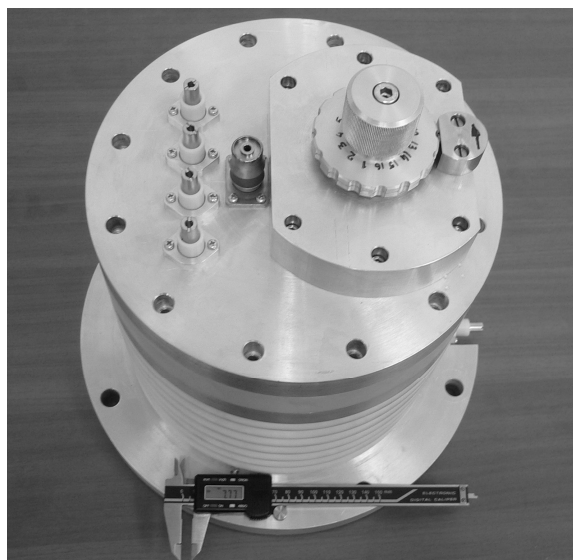

Fig. 2. Mevva-V.RU ion source



Fig. 3. Electrodes of the ion source

produced between the cathode 1 located on the source axis and trigger electrode 8 that leads to the ignition of a surface discharge. A vacuum arc is thus ignited between the cathode 1 and the hollow anode 3. A power supply based on an artificial forming line maintains a vacuum arc discharge current of up to several hundreds of amperes at pulse duration of hundreds of microseconds. The cathode plasma emitted by cathode spots fills the hollow anode 3. On the face of the hollow anode there is a multi-aperture emission electrode with holes through which the ion beam is extracted. The extracting system 4 also includes a cutoff electrode to which a negative voltage of several kilovolts is applied to suppress the secondary electrons knocked out of the electrodes of the extracting system and the target due to ion-electron emission. The current of the vacuum arc discharge was controlled in the range from 30 to 300 A at pulse duration of 200  $\mu\text{s}$  and at a pulse repetition rate of up to 10 Hz. The total ion current extracted from the source reached 0.5 A at an accelerating voltage of up to

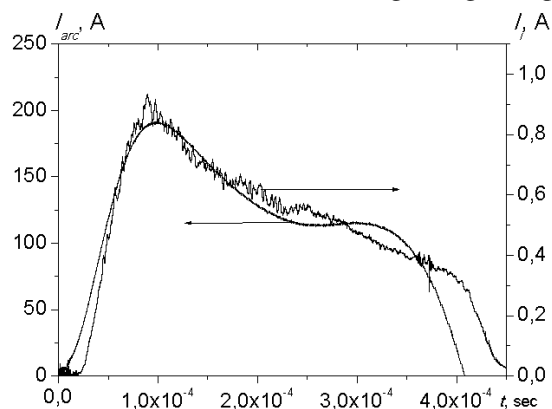

Fig. 4. Waveforms of the currents of the vacuum arc discharge and Zr ion beam. The accelerating voltage: 40 kV

50 kV. The area of the ion beam cross-section at the output of the extracting system therewith amounted to 100  $\text{cm}^2$ . Waveforms of the vacuum arc discharge current and current of the extracted ion beam are shown in Fig. 4.

### 3. Modification of the ion source

The modification of the ion source consisted, primarily, in deciding on optimal voltage and current of the initiating discharge [6]. With the optimal voltage and current of the initiating discharge, the lifetime of each cathode and, thus, of the whole cathode unit was considerably increased. Moreover, the lead-in of the initiating discharge power supply was made on a ceramic bushing insulator that made it possible to increase the operating temperature of the cathode flange of the source. The use of highly strain and heat resistant materials in the ion source design allowed heat removal from the electrodes of the device by mere air convection. This way of heat removal is surely easy to realize compared, e.g., to cooling of the electrodes by deionized water, for which, among other things, a high-voltage decoupling is required.

A shortcoming of the ion source prototype was known to be the large size of the cathode holder that vastly increased the probability of cathode spots occurring on its surface. With cathode spots, the ion beam was "contaminated" by the products of electrode erosion. This trouble was cleared up by covering the surface of the multi-cathode unit with a tantalum shield. This material is characterized by the maximum threshold current at which a cathode spot is ignited. Another difference from the previous version is that the hollow anode of the electrode system was made dismountable. This made cleaning of its surface from cathode material vapors and microdroplets much easier.

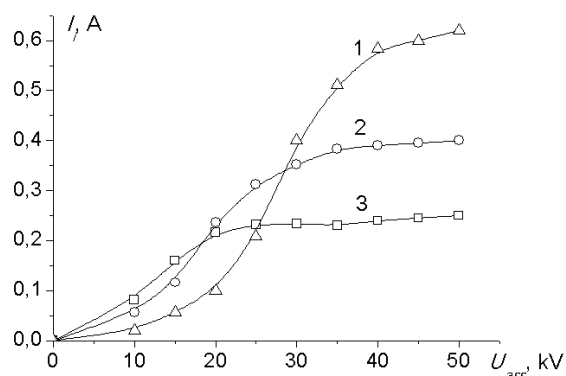

Fig. 5. Current-voltage characteristics of the ion source. The cathode material is magnesium. The discharge current: 1 – 50 A, 2 – 85 A, 3 – 120 A

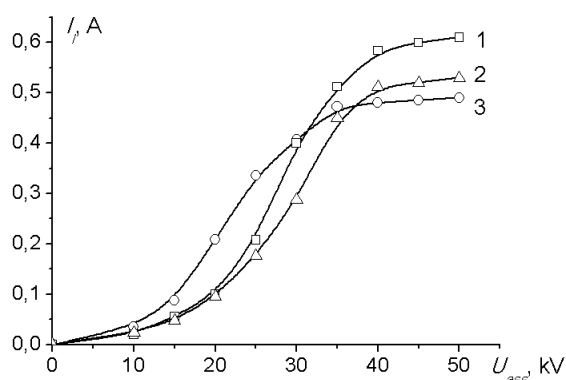

Fig. 6. Current-voltage characteristics of the ion source. The cathode material: 1 – titanium, 2 – zirconium, 3 – magnesium. The discharge current: 1 – 120 A, 2 – 110 A, 3 – 125 A

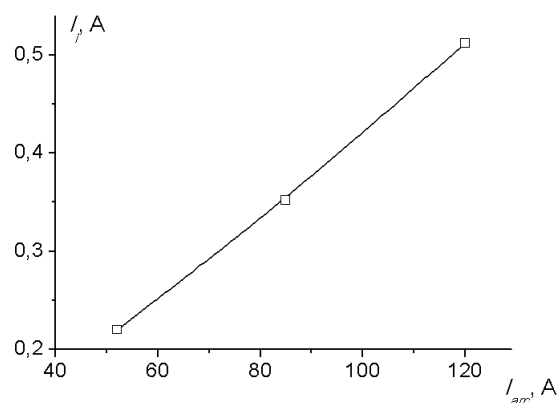

Fig. 7. Emission characteristic of the ion source. The cathode material is titanium. The accelerating voltage: 30 kV

The shortcoming of all types of multi-aperture ion-extracting systems is the necessity of matching the ion emission parameters of the plasma and the parameters of the ion-extracting system each time they are changed. For instance, decreasing or increasing the accelerating voltage causes a change in the position of the plasma boundary in the holes of the

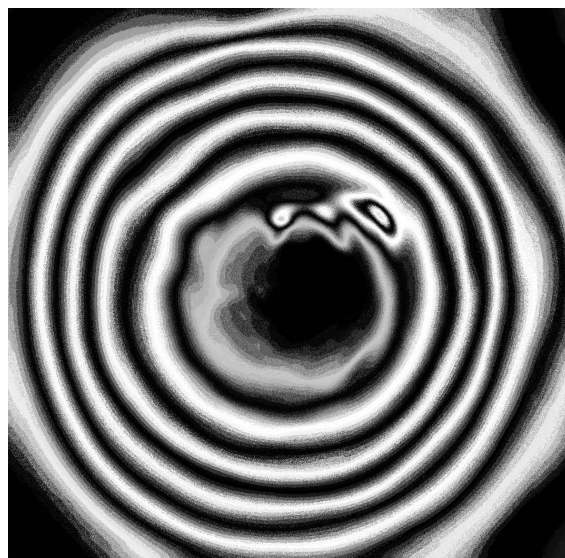

Fig. 8. Trace of the ion beam. The dimensions: 20×20 cm. The cathode material is titanium. The accelerating voltage: 45 kV. The transition from one color to another corresponds to 8.2 % of the intensity of the ion current density

emission electrode. This leads to defocusing of the ion beam and, hence, to a decrease in ion current through losses of ions at the electrodes, to their sputtering under the action of ion bombardment and contamination of the beam by erosion products, and to the occurrence of secondary electrons in the accelerating gap. To eliminate the influence of the accelerating voltage on the beam current, the emission electrode located from the side of the hollow anode face was covered with an additional fine grid of high geometric transparency. The function of this additional element was to stabilize the plasma boundary near the emission electrode in its optimal plane and to hold the position of the plasma boundary constant in a wide range of the plasma density and accelerating voltage. The stabilization of the plasma boundary shows itself up as a portion of ion current saturation on the current-voltage characteristics (CVC) of the ion source (Figs. 5 and 6). It is apparent that the CVC saturation allows control of the accelerating voltage of the ion source without regard to the discharge current. The emission characteristics of the ion source (Fig. 7) are linear that makes it possible to vary the ion beam current by varying the current of the vacuum arc discharge. The distribution of the ion beam current measured from the "trace" left by the ion beam on a plastic target is shown in Fig. 8. Analysis of the image shows that the distribution of the ion current density over the beam cross-section with which a decrease in current density by 50 % of the maximum is found inside a circle of diameter 14 cm and by 30 % inside a circle of diameter 10 cm is characteristic of vacuum arc ion sources [7].

#### 4. Conclusion

Thus compared to the prototype, the Mevva-V.RU version features the lesser degree of contamination of the ion beam by the products of erosion of the cathode holder and electrodes of the extracting system on retention of the reasonable homogeneity of the extracted ion beam, better ion-optic properties of the system of ion beam formation at high accelerating voltages, simple design, reliability and long lifetime of the system of vacuum arc initiation.

#### References

- [1] Review of Scientific Instruments, 2006, 77, No. 3 Special issue (*Proc. 11 International Conference of Ion Sources, Caen, France, Sept. 2005*).
- [2] *Proc. 5<sup>th</sup>, 6<sup>th</sup>, and 7<sup>th</sup> Conference on Modification of Materials with Particle Beams and Plasma Flow*, 2000, 2002, and 2004, Tomsk, Russia.
- [3] A.S. Bugaev, V.I. Gushenets, A.G. Nikolaev, E.M. Oks, K.P. Savkin, P.M. Schanin, G.Yu. Yushkov, I.G. Brown, in book: *Emerging Applications of Vacuum-Arc-Produced Plasma, Ion and Electron Beams* / E. Oks, I. Brown, Eds. Kluwer Academic Publishers. The Netherlands, 2002, pp. 79–90.
- [4] I.G. Brown, *Rev. Sci. Instrum.* 65, 3061 (1994).
- [5] A.G. Nikolaev, E.M. Oks, K.P. Savkin, G.Yu. Yushkov, I. Brown, R. MacGill, *Patent RU 48105 U1*, 2005.
- [6] K.P. Savkin, A.G. Nikolaev, in *Proc. Russian Practical Conf. On Low-temperature Plasma Physics, 2004, Petrozavodsk*, Russia, pp. 230–234.
- [7] Ian Brown and Efim Oks, *IEEE Trans. Plasma Sci.* 33 1931 (2005).