

A Novel Method of Inner Surface Modification by Plasma Electrolytic Oxidation¹

Wei-Chao Gu, Guo-Hua Lv, Huan Chen, Guang-Liang Chen,
Wen-Ran Feng, Gu-Ling Zhang, Er-Wu Niu, Li Li, Si-Ze Yang

*Beijing National Laboratory for Condensed Matter Physics, Institute of Physics,
Chinese Academy of Sciences, Beijing, 100080, P.R. China*

Phone: +86-10-8264-9458; Fax: +86-10-8264-9531, E-mail: yangsz@aphy.iphy.ac.cn

Abstract – Up to now, many researchers focused on the plasma electrolytic oxidation (PEO) processes for workpieces of regular shapes such as cube, cake or stick samples, and no one paid attention to the irregular samples such as tubes. This research focuses on the PEO processes for long tubes, especially on the way to obtain uniform thickness of ceramic coatings on inner surface of tubes. The results show that potential decay from the bottom-ended part to the middle part of the tube comes into being because of the electric field shield effect. The potential decay has detrimental influence on the PEO processes of the inner surface and results in the non-uniform thickness distribution of the PEO coatings on the inner surface. An accessorial electrode was used to eliminate the effect of electric field shield and was effective to obtain axially uniform coating on the inner surface of the tubes.

1. Introduction

Alumina ceramic coatings are potentially very effective in developing wear resistance surfaces that also exhibit excellent corrosion protection. A number of deposition techniques such as arc-discharge plasma and gas-flame spray, vacuum deposition methods and high temperature glass enameling have been investigated to produce ceramic coatings on metals. These techniques require a high substrate temperature to provide adequate coating adhesion at high contact loads. Plasma electrolytic oxidation (PEO), also called micro-arc oxidation (MAO), is a novel technique to fabricate thick and hard ceramic coatings on metals such as Ti, Al, Mg, Nb, etc., and their alloys [1–6]. Earlier research showed that the coatings offered attractive combination of wear resistance, corrosion resistance, mechanical strength, interfacial adhesion and thermal properties [7–9]. This is especially true to aluminum and its alloys in aerospace, automotive, textile engineering, etc.

Up to now, almost all of these researches focused attention on the PEO process for workpieces of regular shapes such as cube, cake or stick samples. However, in spite of numerous studies and extensive prac-

tical use, there is still no systematic research concerned with the PEO processes of irregular workpieces. Attempt of plasma electrolytic surfacing for spinning rotor, water hydraulic pump and electro-hydraulic servo motor showed that it was impossible to obtain uniform ceramic coatings on their surface [10–12], but no in-depth study has been made by these researchers.

Therefore, the objective of this work was to study the PEO behavior of one special irregular workpiece, aluminum tubes: the influence of electrode mode and electrode shape on the potential distribution inside tubes of different length and diameter, and the relationship between potential distribution and coating thickness.

2. Experimental procedure

Experiments were carried out in an apparatus shown in Fig. 1. The apparatus includes a stainless steel electrolyte bath of 5 liters in volume containing electrolyte, which is also served as a cathode. Anodic electrode is cannular aluminum tubes of different length and diameter immersed in the electrolyte. Experiments were made in an aqueous of sodium hydroxide (NaOH), sodium silicate (Na_2SiO_3) and sodium hexametaphosphate ($(\text{NaPO}_3)_6$) of the chemical grade solution at concentration of 0.025 M, 0.066 M and 0.008 M, respectively. Voltage was applied to the electrodes from a pulse dc power supply unit. The electrolyte was mixed with a stirrer to ensure that the composition and concentration of the electrolyte inside the tube was homogeneous throughout volume during the PEO processes.

In the tentative experiment we found that the discharge morphology was just the same as regular samples on the outer surface of the tube, but it was obvious that there was no legible sparks inside the tube, especially at the middle part of the inner tube. So two detecting samples (Aluminum wire, $\varnothing 3$ mm) were placed at the position of 5 and 6 as shown in

¹ The work was supported by the National High Technology Research and Development Program of China (863 Program) under Grant No. 2002A331020.

Fig. 1. The samples were taken out after processed for a short period of time. Fig. 2 shows the surface morphology of the detecting samples after PEO processes, and sample 0# which is shown for comparison with sample 5# and 6# is unprocessed. From Fig. 2 we can see that there is a thickness decay of sample 5# from the end part to the middle part. It is presumed that the electric field distribution inside the tube must have great influence on the thickness decay, so a potential meterage system was built to measure the potential of different points inside the tube.

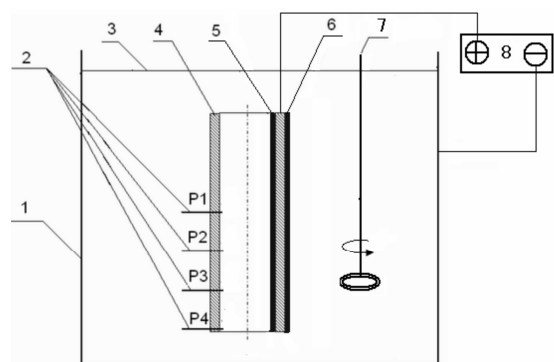

Fig. 1. Schematic of the experimental apparatus 1. Electrolytic bath (cathode); 2. Probes; 3. Surface of the electrolyte; 4. Aluminum tube; 5, 6. Detecting samples; 7. Stirrer; 8. Power supply

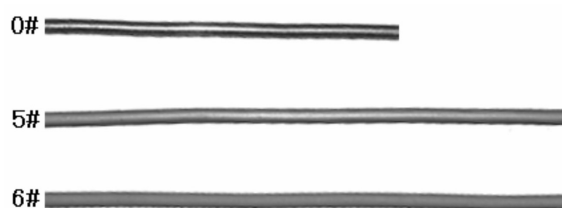

Fig. 2. Morphology of the detecting samples after PEO process. (The number is corresponding to Fig. 1. Sample 0# is unprocessed)

As shown in Fig. 1, four electric probes were used to measure the potential distribution inside the tube. These electric probes were covered with an insulated layer and mounted normal to the generatrix of the inner surface of the tube. The open face end of the probes served as flat probes. The vertical distance between the inner surface and the measure points was less than 0.5 mm. The Potential difference between these probes and the negative electrode were recorded with an oscillograph (Tektronix TDS2012, 100 MHz). After PEO processes, the tubes under same treating time were cut off, and the thickness and cross section of the coatings inside tubes were investigated by HITACHI S4200 scanning electron microscopy (SEM).

3. Results and discussion

During experiment, the applied voltage across the electrodes (V) was monitored continuously. The

results of the measurement of these parameters, applied voltage between cathode and anode and voltage drop between four probes and cathode, are given in the illustrations mentioned below. The results are obtained by analyzing data of five runs. Spread in values in different runs generally does not go beyond the error limits of 5 %.

An aluminum tube of 120 mm in length and 12 mm in inner diameter was firstly used in our experiment. After the system was powered under the constant current, the voltage between the electrodes increased rapidly to 200 V. An intense gas evolution was clearly observed at the outer surface of tube, along with some luminescence at the surface, which was eventually replaced by the onset of white glow discharge morphology is in accordance with the PEO processes of the regular samples. But it was obvious that there was no legible sparks inside the tube, especially at the middle part of the inner tube.

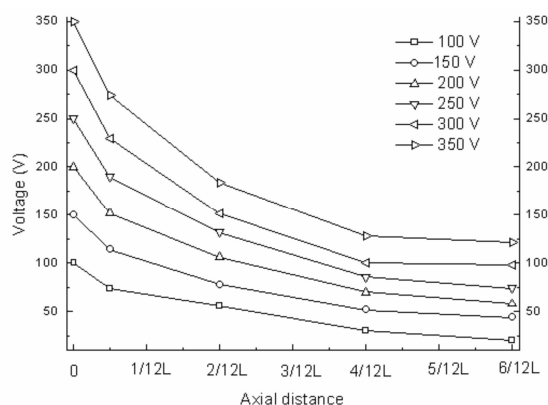

Fig. 3. Potential decay from the tube of the bottom-ended part to the middle part under different applied voltage without accessorial electrode

Fig. 3 shows the potential decay from the bottom-ended part of the tube to the middle part under different applied voltage. It can be noted that obvious potential difference comes into being inside the tube, and the potential is the lowest at the middle part of the tube. Potential difference of the bottom-ended part and the middle part of the tube, i.e. ΔV_{\max} , under different applied voltage is shown in Fig. 3. We can see that when the applied voltage is 100 V, ΔV_{\max} is 70 V, but when the applied voltage reached 200 V (critical voltage that discharge occurs at the outer surface), ΔV_{\max} becomes 142 V. This means that when the glow discharge appears around the outer surface of the tube, the voltage at the middle part of the tube is only 58 V, which is far below the critical discharge voltage.

In the above experiment, a tube with the Diameter/Length (D/L) ratio of 0.1 was used to measure the potential difference. Tubes of different D/L ratio were also tried, and uniformity of potential distribution inside the tube (U) was defined as follows,

$$U = V_{in} / V_{out}$$

where V_{in} is the voltage at the middle part of the tube, and V_{out} is the voltage at the bottom-ended part of the tube.

The results show that the uniformity of potential distribution inside the tube (U) increases when D/L ratio increases [shown in Fig. 4]. It means that the longer and thinner the tubes become, the thinner the coatings at the middle part of the tube will be.

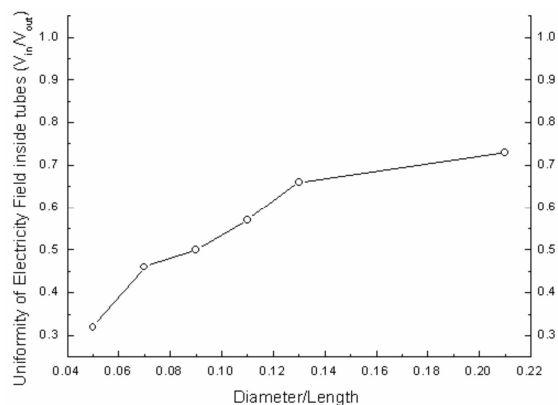

Fig. 4. Uniformity of electric field inside tubes of different size

It is obvious that potential decay inside tubes bring forth an unhomogeneous electric field from the bottom-end part to the middle part of the tubes, which has a detrimental effect on the PEO behavior to obtain symmetrical ceramic coatings on the inner surface of tubes. Therefore, a central accessorial electrode was axially symmetric placed inside tubes to gain homogeneous potential distribution inside tubes. Fig. 5 is the potential distribution from the tube of the bottom-ended part to the middle part under different applied voltage with an accessorial electrode, which shows that the central accessorial electrode is effective to obtain axially homogeneous potential distribution inside the tube, and the potential difference between the tube of the bottom-ended part and the middle part is no more than 5 V.

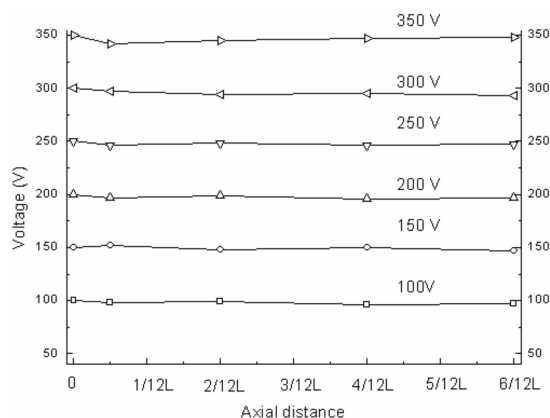

Fig. 5. Potential distribution from the tube of the bottom-ended part to the middle part under different applied voltages with accessorial electrode

So a simple central accessorial electrode changes the potential distribution inside the tube. When no central accessorial electrode is employed during PEO processes, potential decay from the tube of the bottom-ended part to the middle part is created because of the electric field shield effect [13]. The potential difference brings forth a homogeneous electric field from the bottom-end part to the middle part of the tubes, which is shown in Fig. 6, a. Whereas, after central accessorial electrode was axially used to eliminate the effect of potential decay inside tubes, axially uniform electric field inside the tubes was obtained, just as Fig. 6, b.

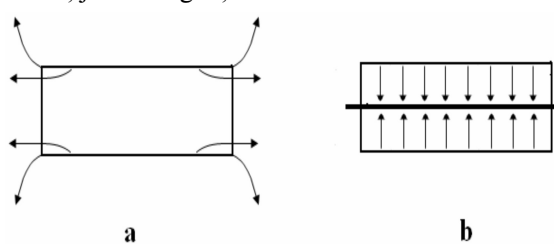

Fig. 6. Electric field distribution inside the tube with-out (a) and with (b) accessorial electrode

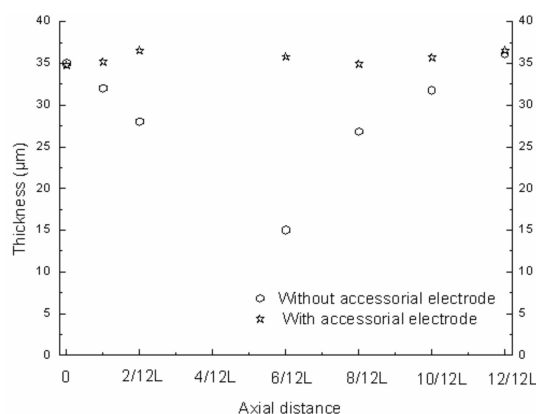

Fig. 7. Coating thickness distribution inside tubes treated with and without accessorial electrode

Further research has been done to obtain the precise data about the coatings thickness under different electrode mode. After PEO processes with and without central accessorial electrode, the samples treated under same parameters ($i=160 \text{ A/m}^2$, $t=30 \text{ min}$) were taken down and cut off at different distance from the end of the tubes, and then the cross section was measured by scanning electron microscopy (SEM). Fig. 7 shows the results, which has the same trend compared with the potential distribution inside tubes with and without the central accessorial electrode. The different kinetics of PEO coatings under different electrode mode can be explained by the different electric field distribution described in Fig. 6. When no central accessorial electrodes are employed during PEO, the voltage at the middle part of the tubes is always lower than the end part and the surface of

the tubes, so thickness decay comes into being. But after central accessorial electrodes are employed, there is no potential difference inside the tubes, and that is why axial symmetrical coating thickness can be obtained.

The above results indicate a feasible way to fabricate uniform PEO protective coatings on inner surface of tubes since PEO ceramic coatings exhibit excellent wear resistance, corrosion resistance and adhesion. But in the practical application, the central accessorial electrodes may not be axially symmetric placed inside tubes strictly, especially for the PEO processing of long tubes. So a flexural accessorial electrode was designedly used in the experiment to measure the potential distribution inside the tube.

Meterage results show that the flexural accessorial electrode does not disturb the homogeneous electric field inside the tube. Tran and his colleague found that the voltage drop from the cathode to any point more than 0.5 mm away from the anode was less than 1% of the maximum applied voltage during PEO processes [1]. So we consider that the flexural accessorial electrode has no remarkable influence on the potential distribution inside tubes. The result shows that even the central accessorial electrodes are not axially symmetric placed inside tubes, axial symmetrical coating thickness can also be obtained on the inner surface of tubes.

4. Conclusions

The PEO behavior of aluminum tubes has been investigated in this work. Measurement of the potential difference inside tubes without central accessorial electrode shows that potential decay from the tube of the bottom-ended part to the middle part comes into being because of the electric field shield effect. The potential decay has serious influence on the PEO process of the inner surface and results in the nonuniform thickness distribution of the PEO coatings on the inner surface. Whereas, after central accessorial electrodes, whether they are axially symmetric placed or not, are used to eliminate the effect of potential decay inside tubes, axially uniform coatings on the inner surface of the tubes can be obtained.

Acknowledgements

Financial support for this work were provided by the National High Technology Research and Development Program of China (863 Program) under Grant No. 2002A331020.

References

- [1] T.B. Van, S.D. Brown, G.P. Wirtz. *Am. Ceram. Soc. Bull.* 56, 563 (1977).
- [2] A.L. Yerokhin, A. Leyland, A. Matthews. *Appl. Surf. Sci.* 200, 172 (2002).
- [3] P.I. Butyagin, Ye.V. Khokhryakov, I. Mamaev. *Mater. Lett.* 57, 1748 (2003).
- [4] A.L. Yerokhin, L.O. Snizhko, N.L. Gurevina, A. Leyland, A Pilkington, A Matthews. *J. Phys. D: Appl. Phys.* 36, 2110 (2003).
- [5] P.A. Dearnley, J. Gummersbach, H. Weiss, A.A. Ogwu, T.J. Davies. *Wear.* 225–229, 127 (1999).
- [6] G.P. Wirtz, S.D. Brown, W.M.. Kriven. *Mater. Manuf. Process.* 6, 87 (1991).
- [7] W. Xue, C. Wang, Z. Deng, R. Chen, Y. Lai, Tonghe Zhang. *J.Phys.:Condens.Matter.* 14, 10947 (2002).
- [8] J.A. Curran, T.W. Clyne. *Surf. Coat. Technol.* 199, 168(2005).
- [9] Yaming Wang, Tingquan Lei, Bailing Jiang, Lixin Guo. *Appl. Sur. Sci.* 233, 258 (2004).
- [10] Lai Yongchun, Song Hongwei, Chen Ruyi, Xue Wenbin, Deng Zhiwei, Zhang Longhai, Hu Zhigang, Zhao Juan. *Journal of Beijing Normal University*, 33, 59 (1997). (in Chinese)
- [11] Li Shangyi, Zhao Keding, Chang Tongli, Gong jianjun. *Chinese Hydraulics & Pneumatics.* 12, 43 (2004). (in Chinese)
- [12] Wang Qiang, Jiang Jihai, Wu Shenglin, Li Kuifeng. *Chinese Hydraulics & Pneumatics.* 8, 72 (2005). (in Chinese)
- [13] Zhao Kaihua, Chen Ximou. *Electrics & Magnetism*, Beijing, High Education Press, 2003, pp. 27–29. (in Chinese)